



Saturday, November 14th

Please fill out new membership form, even if there are no changes and submit with payment. Payment is due Jan 1st but early payment in Nov and Dec would be appreciated. You may also pay by mail. SFTS will start at the Jan 2021 match! If you already paid, please pick up your membership card at registration window.

Stage Conventions:

"Default" starting position is standing upright, hands at sides and not touching anything unless otherwise indicated. "Default" is still required for the rest of your body when hand(s) have a specific position. i.e. "hands on hat" does not allow shooter to be bent over the gun.
"At the ready" starting position is standing any way shooter desires, not touching ammo or guns.

Starting position is at center of position unless otherwise indicated.

For lateral movement, to be in position at least one foot must be behind prop.

For downrange movement, to be in position shooter must be close enough to the prop to ground or stage a gun without taking a step. Duelist may rest butt of shotgun on prop instead of staging.

Targets are to be engaged as specified unless stage instruction provides options. EXAMPLE is provided for clarity when there are options.

Comstock Rules: All S/G targets MAY be re-engaged "Comstock Rules." S/G targets may be re-engaged at the end of the shotgun string or at the moment they've been missed, unless the stage description says otherwise. S/G targets should be re-engaged from where they were initially engaged.

Stage 1

November 14th, 2020



10 Pistol, 10 Rifle, 4+Shotgun

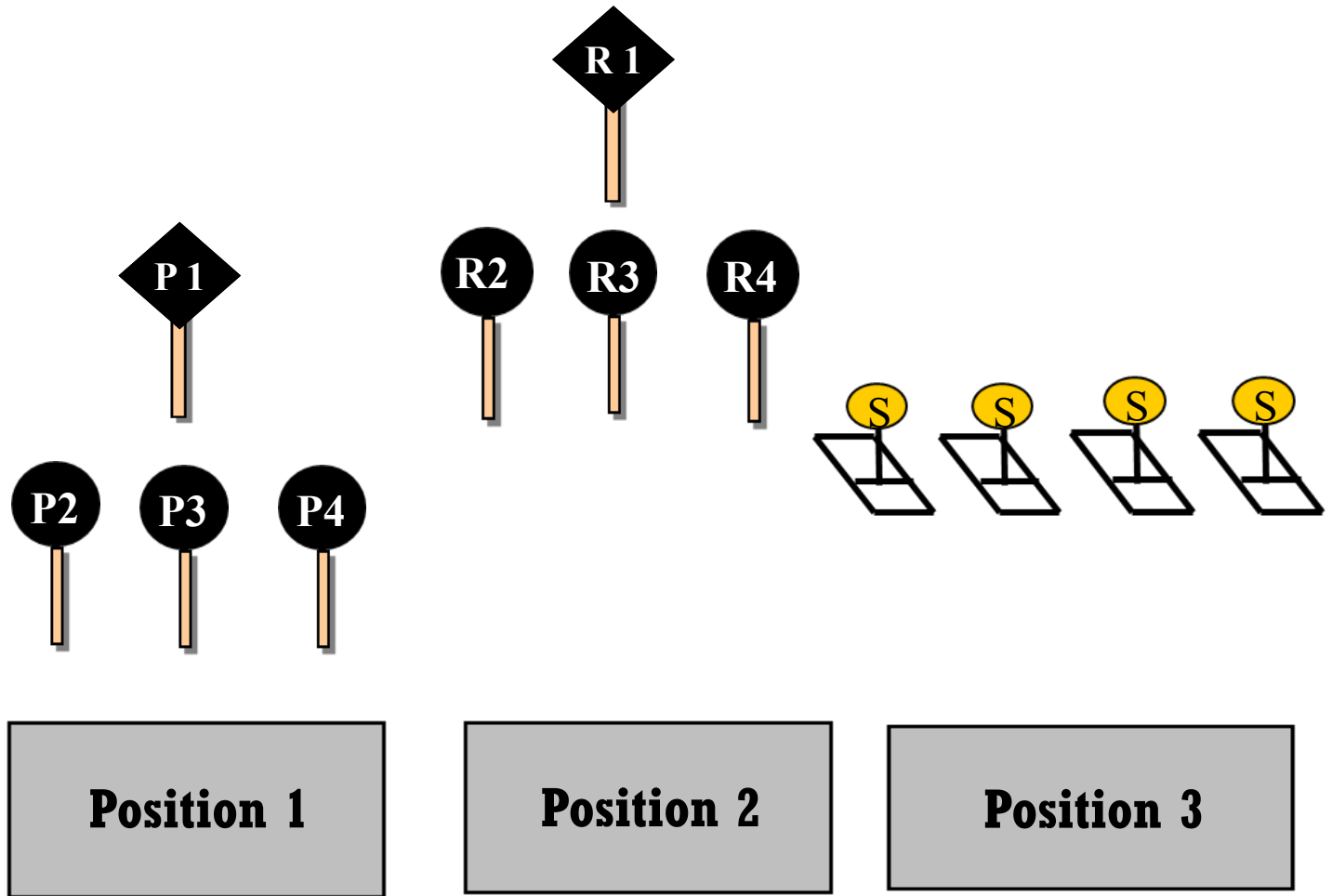

Stage may be shot Left to Right or Right to Left, shooters choice. SASS Default. Rifle staged at position 2, open and empty shotgun staged anywhere safely, pistols loaded with 5 rounds each and holstered. To signify ready, shooter says: "I wouldn't leave this town at noon for all the tea in China."

At buzzer, with pistols, double tap P1, then sweep P2-P4 from either end, repeat sweep on P2-P4 from either end, then double tap P1 for a total of 10 rounds. From position 2, with rifle, repeat pistol instructions for a total of 10 rounds. From position 3, engage 4 shotgun targets in any order until down.

TAKE TIMER TO NEXT STAGE

Stage 2

November 14th, 2020



10 Pistol, 10 Rifle, 4+Shotgun

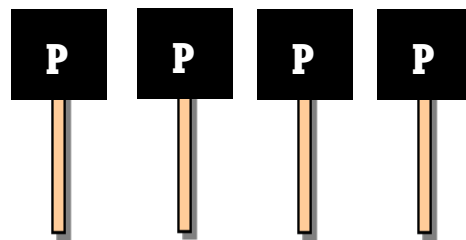
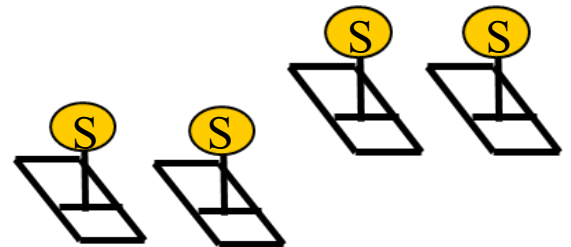
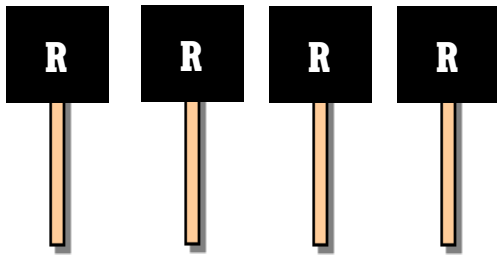

Position 1

Position 2

Position 3

Start at position 1, hand(s) on rifle staged flat on table. Open and empty shotgun staged anywhere safely, pistols loaded with 5 rounds each and holstered.

To signify ready, shooter says: "It's no good, I've got to go back, Amy."

At buzzer, with rifle, engage the 2 outside R targets with 3 rounds each and the 2 inside R targets with 2 rounds each with **no triple taps** for a total of 10 rounds. From position 2, with pistols, engage the 4 P targets as per rifle instructions.

From position 3, with shotgun, engage 4 shotgun in any order until down. This is a round count stage

TAKE TIMER TO NEXT STAGE

Stage 3

November 14th, 2020



10 Pistol, 10 Rifle, 4+Shotgun

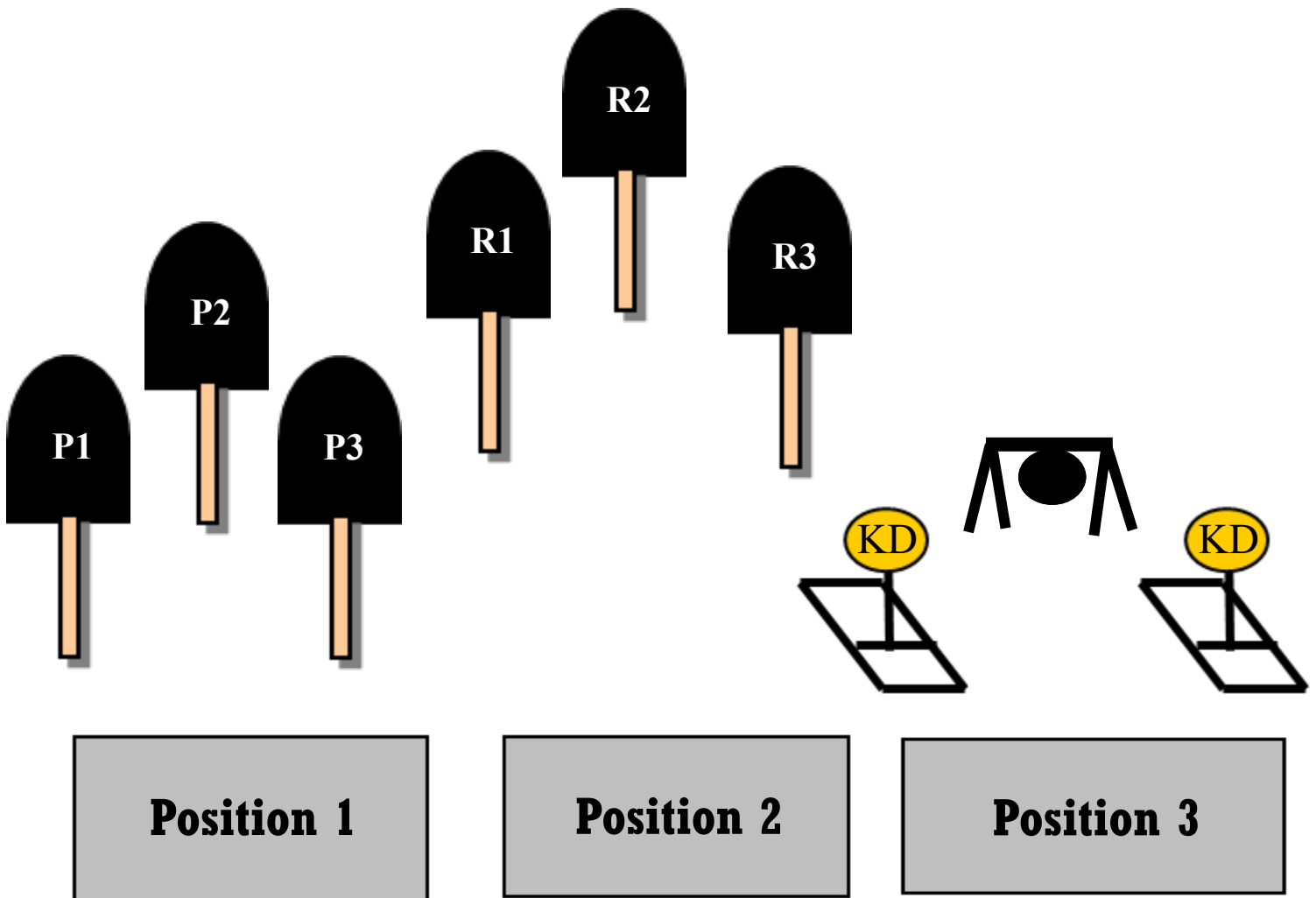

Stage may be shot Left to Right or Right to Left, shooters choice.
Start at center of position 1 or position 3 with first firearm to be used in hand(s).

Rifle is not last.

Rifle loaded with 10 rounds and open and empty shotgun staged anywhere safely, pistols loaded with 5 rounds each and holstered.

To signify ready, shooter says: "Get on that horse, Will."

At buzzer, from Position 1, with pistols, first engage P1 & P3 once each then triple tap P2, then repeat for a total of ten rounds. From Position 2, with rifle, engage R1 -R3 same as pistol instructions. From position 3, with shotgun, engage the shotgun targets, knock down, swinger, knock down, swinger.

TAKE TIMER TO NEXT STAGE

Stage 4

November 14th, 2020



10 Pistol, 10 Rifle, 4+Shotgun

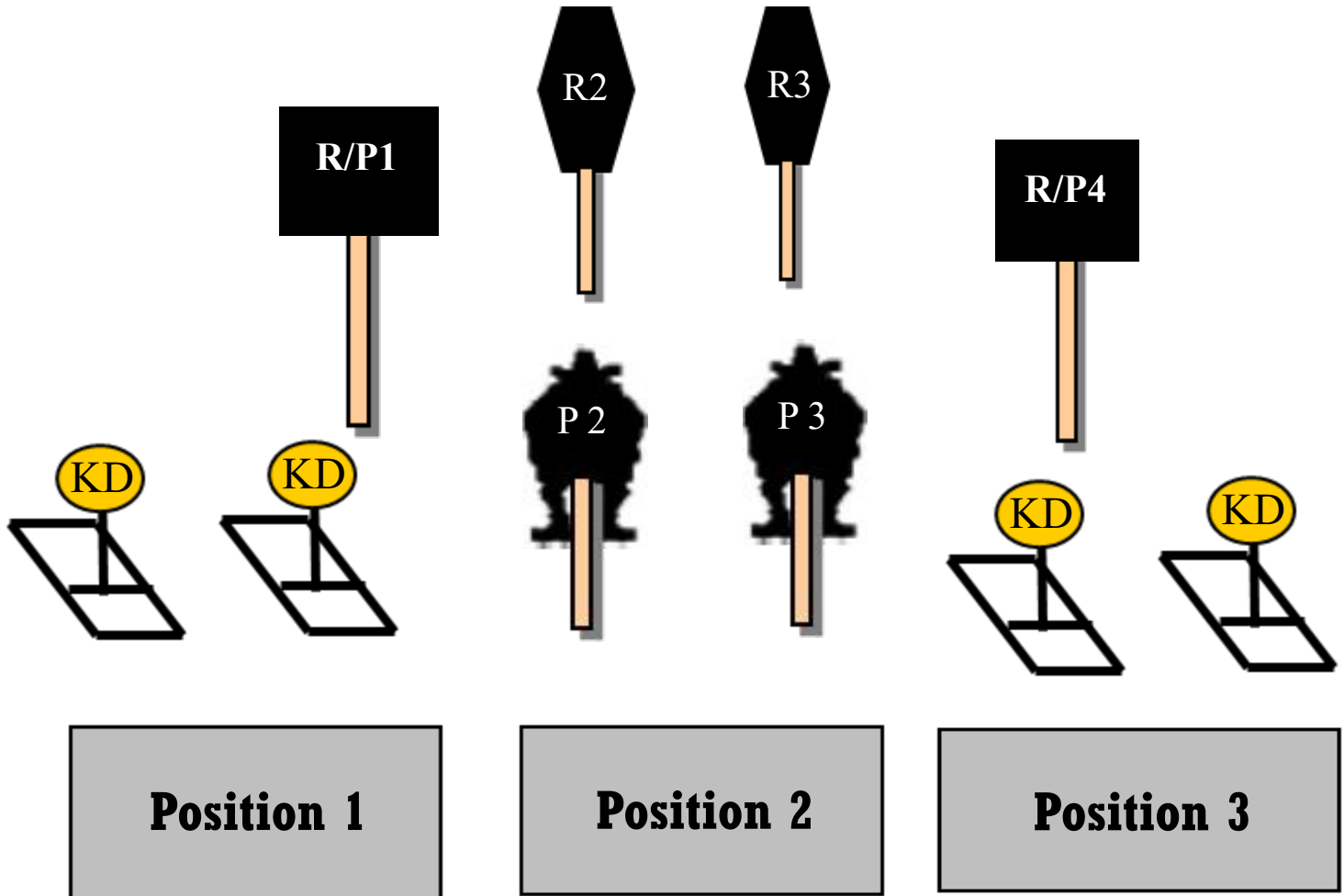

Stage may be shot Left to Right or Right to Left, shooters choice.
Start at position 1 or position 3 shotgun in hands standing behind center of table.
Rifle loaded with 10 rounds staged at position 2, pistols loaded with 5 rounds each and holstered.

To signify ready, shooter says: "Do not forsake me, Oh my darlin"

At buzzer, from Pos 1 (or Pos 3), engage the 2 shotgun targets in front of you until down then **take shotgun with you**. From position 2, with pistols, engage RP1-P2-P3-RP4 in a 2-3-3-2 sweep starting from either end for a total of 10 rounds **and**, with rifle, engage RP1-R2-R3-RP4 same as pistol instructions. Then, retrieve shotgun and with at least one foot behind table at Pos 3 (or Pos 1), engage the 2 remaining shotgun targets.

Pistols and rifles at position 2 may be shot in either order.

TAKE TIMER TO NEXT STAGE

Stage 5

October 10th, 2020



10 Pistol, 10 Rifle, 4+ Shotgun

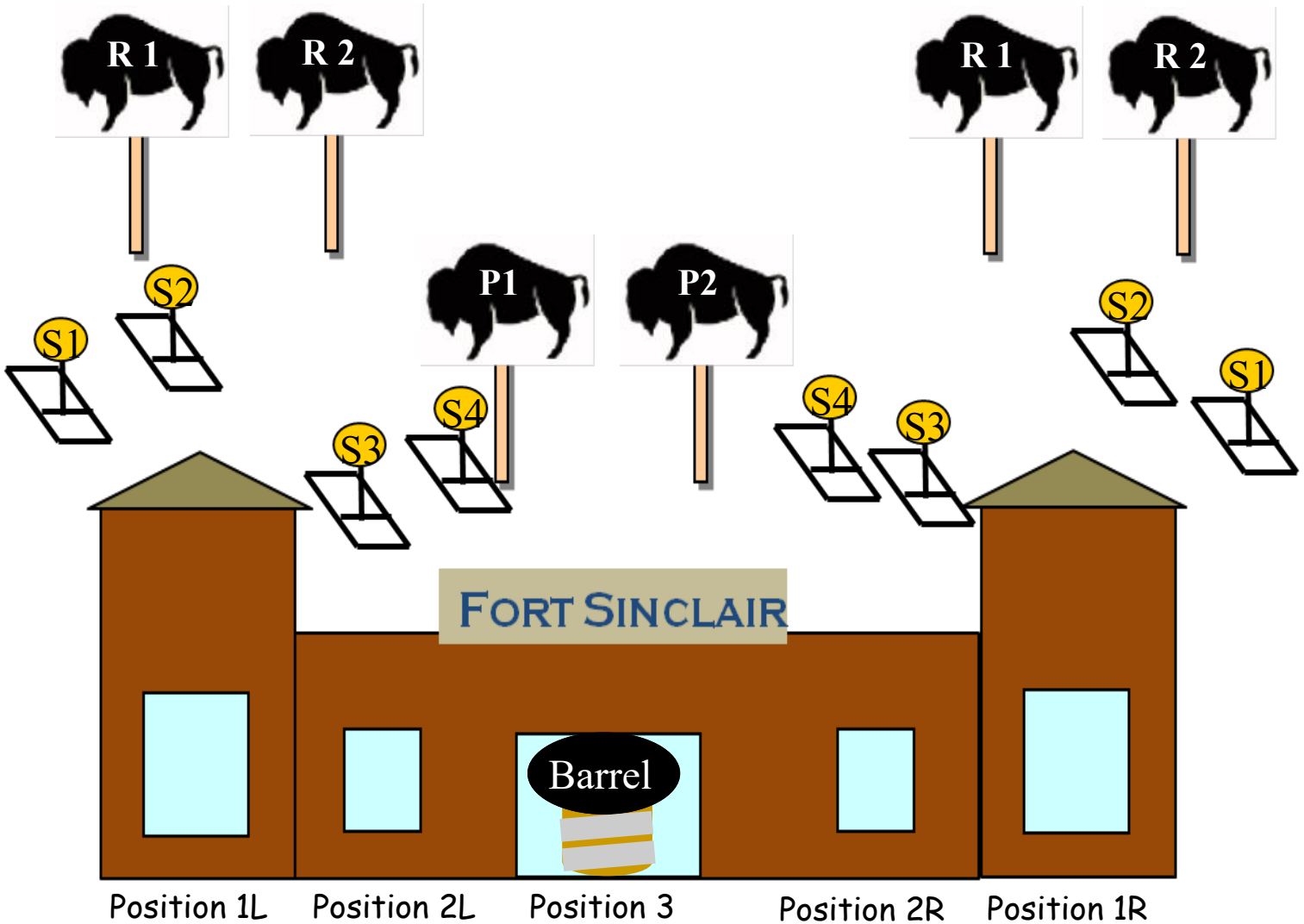

Start inside either tower Position 1L or 1R, rifle loaded with 10 rounds in hands. Open and empty shotgun staged on shelf inside either tower Position 1L or 1R. Revolvers loaded with 5 rounds each, holstered.

To signify ready, shooter says: "Don't shove me, Harv. I'm tired of being shoved."

At buzzer, with rifle, engage R1 & R2 with alternating double taps for 10 rounds, starting on either target **and also** at Position 1L (or 1R) engage shotgun targets S1 and S2, then from position 2L (or 2R) engage S3 and S4. At Position 3, with pistols, engage P1 & P2 with same instructions as rifle.

TAKE TIMER TO NEXT STAGE

Stage 6

October 10th, 2020

10 Pistol, 10 Rifle, 4+Shotgun

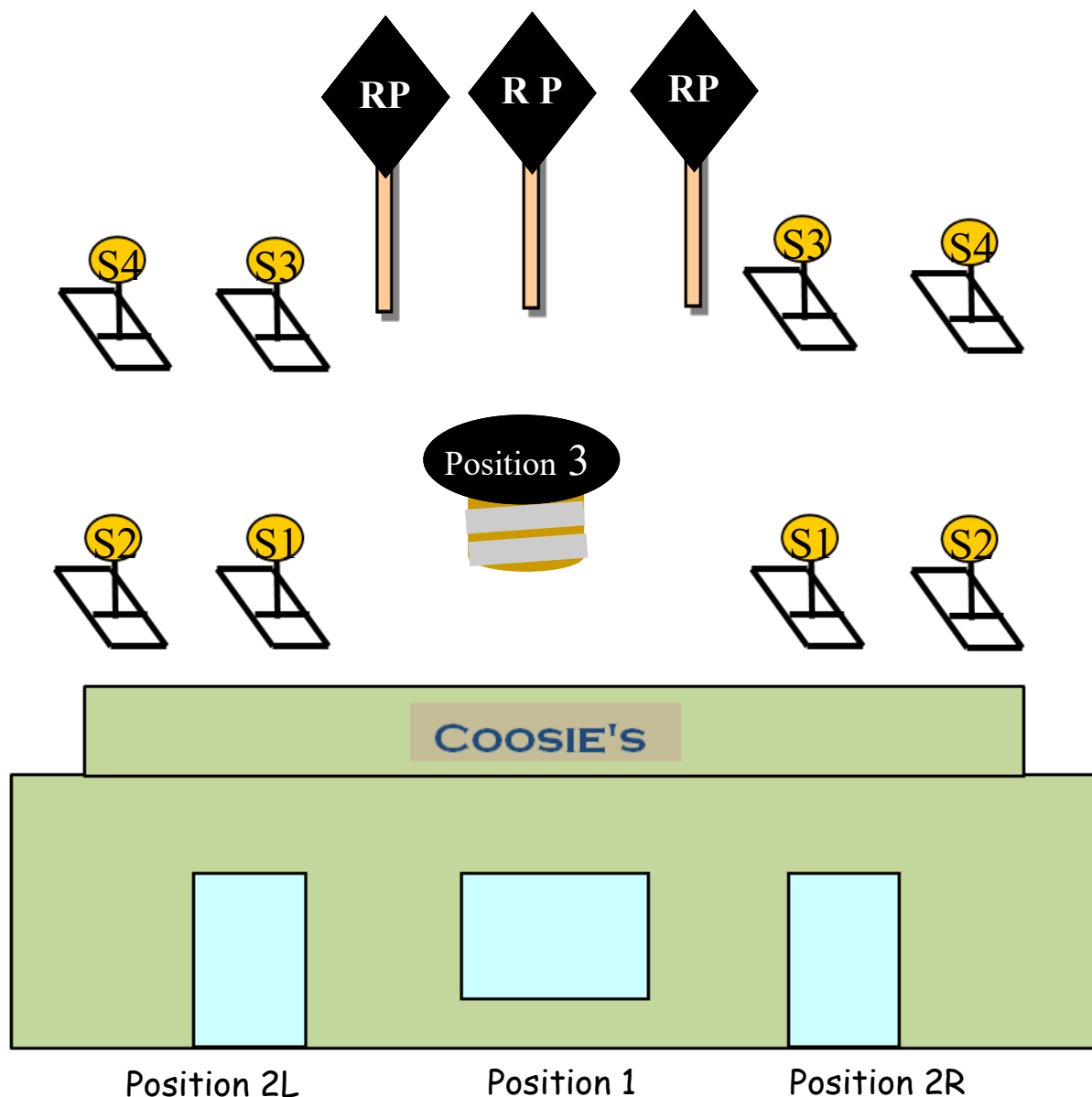

Start inside Coosie's at position 1 at low surrender. Rifle loaded with 10 rounds staged on table at position 1, shotgun staged anywhere safely inside Coosie's, pistols loaded with 5 rounds each, holstered.

To signify ready, shooter says: "How is Miss Ramirez?"

At buzzer, with rifle, engage the 3 R/P targets in a 2-1-2 sweep, starting on either end then repeat the sweep **from the same direction** for total of 10 rounds. Make rifle safe **vertically**. From position 2R (or 2L), engage shotgun targets S1 & S2 from behind door threshold (both feet completely behind the timber threshold). Then engage S3 & S4 anywhere between the doorway and the barrel at position 3. Make shotgun safe on barrel at Position 3 and, with pistols, engage the 3 R/P targets as per rifle instructions.

TAKE TIMER TO NEXT STAGE