



October 10, 2020

Happy Halloween

You're a rumor, recognizable only as deja vu and dismissed just as quickly. You don't exist; you were never even born. Anonymity is your name. Silence your native tongue. You're no longer part of the System. You're above the System. Over it. Beyond it. We're "them." We're "they." We are the Men in Black.

**Match fees increase in January, membership dues remain the same. Please fill out new membership form, even if there are no changes and submit with payment. Payment is due Jan 1st but early payment in Nov and Dec would be appreciated. You may also pay by mail. SFTS will start at the Jan 2021 match!**

**If you pay by mail, please send to Black Fire Opal Annie, ACSA Secretary:**

**Sharon Siverts  
1875 South 222nd Ave  
Buckeye, AZ 85326**

# Stage 1 Oct. 2020



9 rifle ,10 pistol , 4 shotgun

Bay C

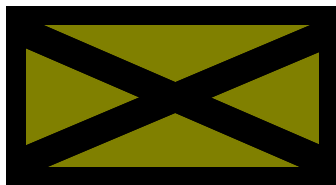
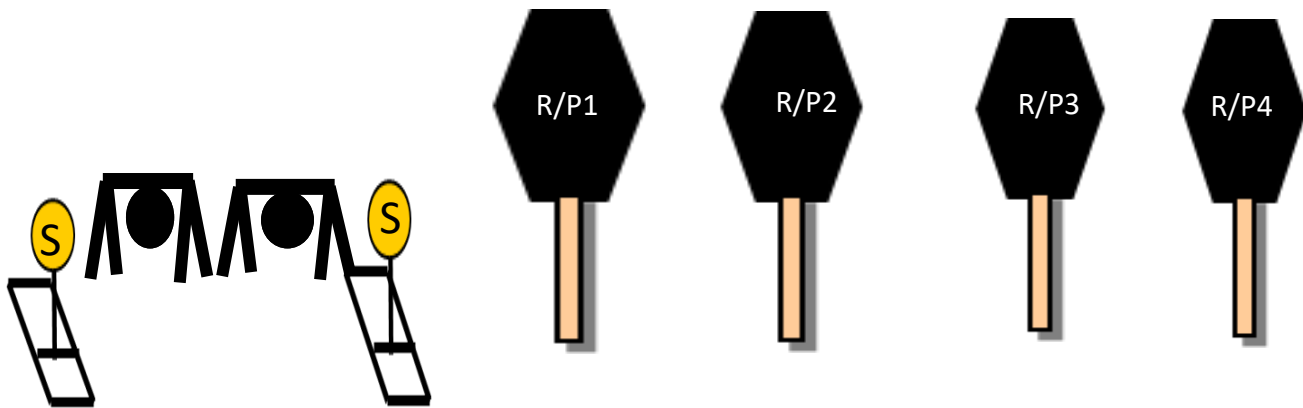

Position 1

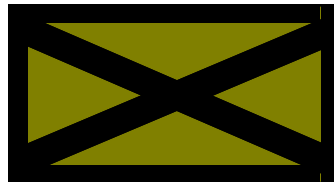

Position 2

Start hands on hat at position 1, rifle loaded with 9 rounds staged at position 2, open empty shotgun staged at position 1, pistols loaded 5 rounds each and holstered.

To signify ready says: "TRICK OR TREAT?"

From position 1 engage the 4 shotguns any order. Make shotgun safe.

From position 2 engage the 4 R/P targets in a 1873 sweep starting on the left. NOTE: RIFLE CANNOT BE LAST.

**1873 sweep**

# Stage 2 October 2020

10 Pistol, 10 Rifle, 4 +Shotgun

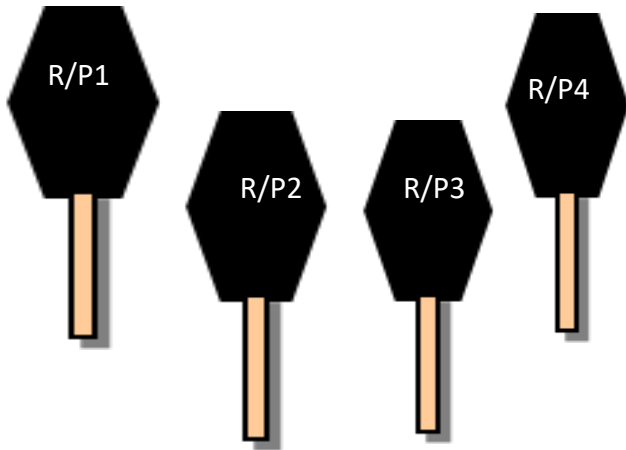

Bay C

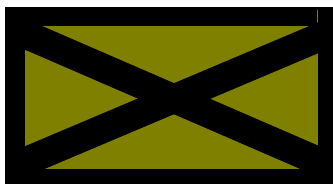
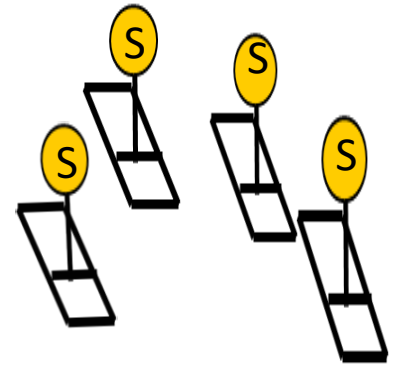

Position 1

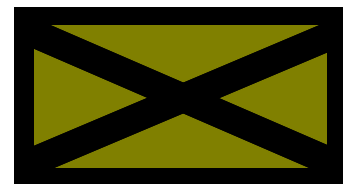

Position 2

Start at position 2, arms folded across chest. Rifle loaded with 10 rounds staged at position 1, Pistols loaded with 5 rounds each holstered, open empty Shotgun staged at position 2.

To signify ready shooter says: " THIS IS A TRICK ".

From position 1 (may start with rifle or pistols first) engage the 4 targets as follows: outside, outside, inside, inside, outside, outside, inside, inside, outside, outside. Repeat instructions for second firearm. Make firearms safe.

Move to position 2 and engage the 4 shotgun targets outside, outside, inside, inside.

**Out/out/in/in/out/out/in/in/out /out**

# Stage 3 Oct 2020



10 Pistol, 10 Rifle, 4+ Shotgun

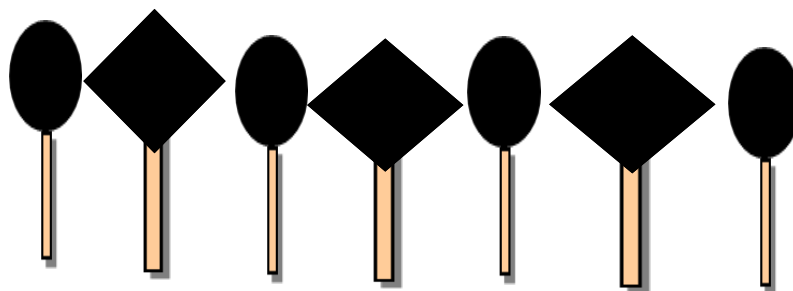

BAY D

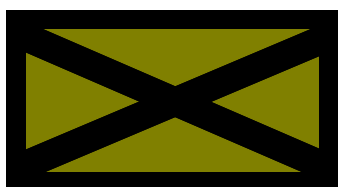
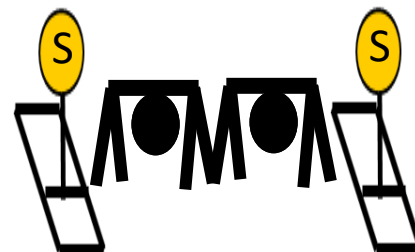
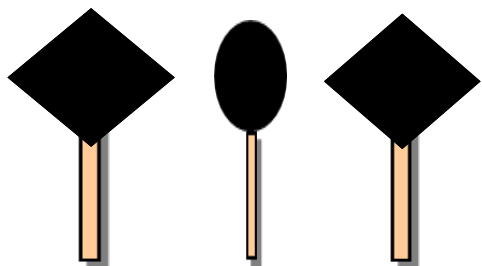

Position 1

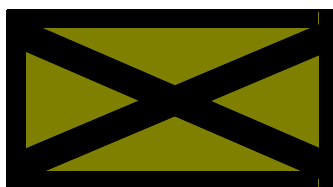

Position 2

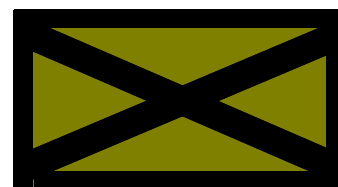

Position 3

Start at the ready with any firearm in hand at any position. Rifle loaded with 10 rounds staged any where safe, open and empty shotgun staged anywhere safe, pistols loaded with 5 rounds each and holstered. Rifle may not be last.

To signify ready shooters says: **“WE’RE NOT HOSTING AN INTERGLACTIC KEGGER DOWN HERE!”**

From Position 1 with Pistols put 2 rounds on the diamonds and one round on the circle for 5 rounds and repeat with 2nd pistol.

At Position 2 with rifle put 1 round on each circle and 2 rounds each on the diamonds.  
From position 3 engage the 4 shotgun targets any order.

# Stage 4 October 2020

10 Pistol, 10 Rifle, 4 +Shotgun

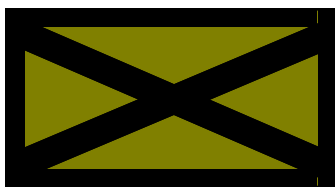
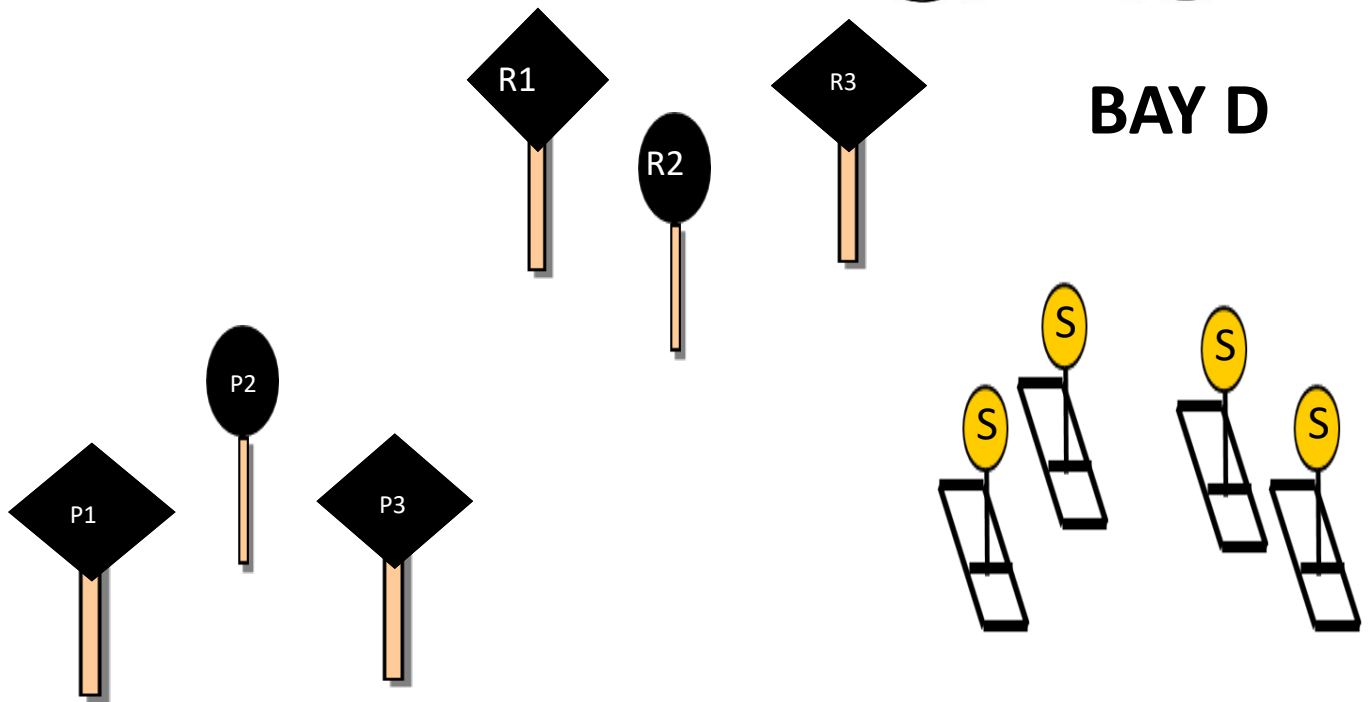

Position 1

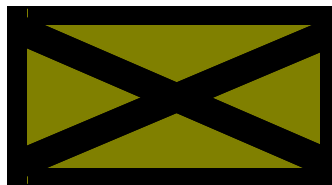

Position 2

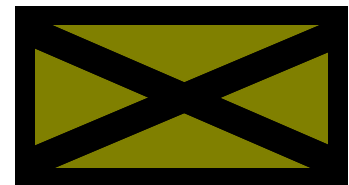

Position 3

Start any position in a high surrender. Rifle loaded with 10 rounds staged anywhere, Pistols loaded 5 rounds each and holstered, open/empty shotgun staged anywhere.

To signify ready, shooter says: "PUT UP YOUR ARMS AND ALL YOUR FLIPPERS".

From position one engage the pistols targets in a 3,4,3 sweep starting either end.

From Position 2 with Rifle engage the rifle targets same as the pistol instructions .

From Position 3 engage the shotgun targets any order. Note: rifle cannot be last.

**A 3,4,3 sweep**

# Stage 5 October 2020

10 Pistol, 10 Rifle, 4 +Shotgun

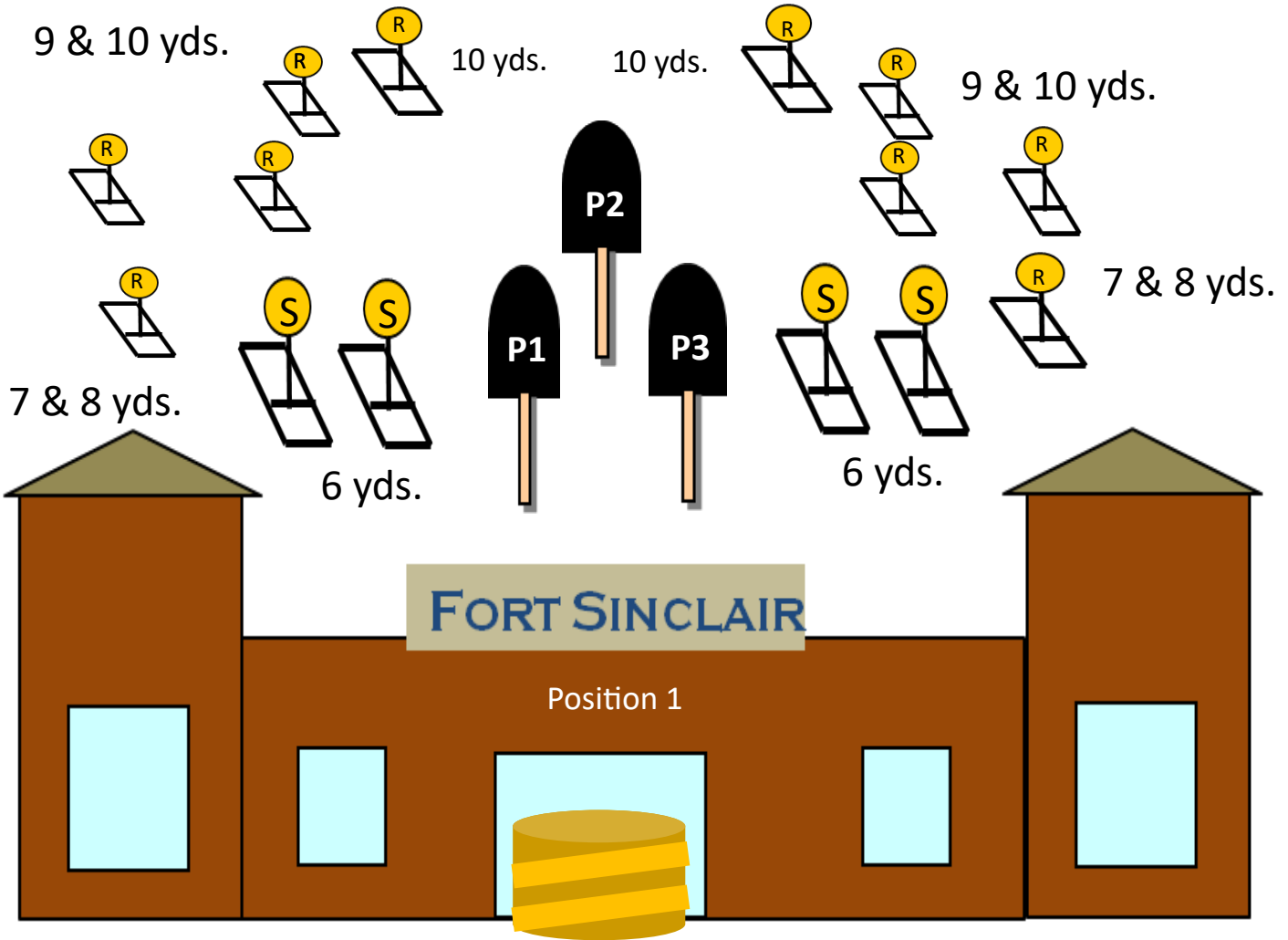

Start at Position 1, mind altering tool in hand. Rifle loaded with 10 rounds staged at position one. Pistols loaded with 5 rounds each and holstered. Open/empty Shotgun staged at position 1.

To signify ready, shooter says, THAT GUYS GOTTA BE AN ALIEN

From Position 1 with rifle, engage 10 knockdown targets. Make rifle safe.

With shotgun engage 4 shotgun targets and any rifle targets still standing . Make shotgun safe.

With pistols engage the pistol targets in a 2, 1, 2 sweep twice from either end.

# Stage 6 October 2020

10 Pistol, 10 Rifle, 4+ Shotgun

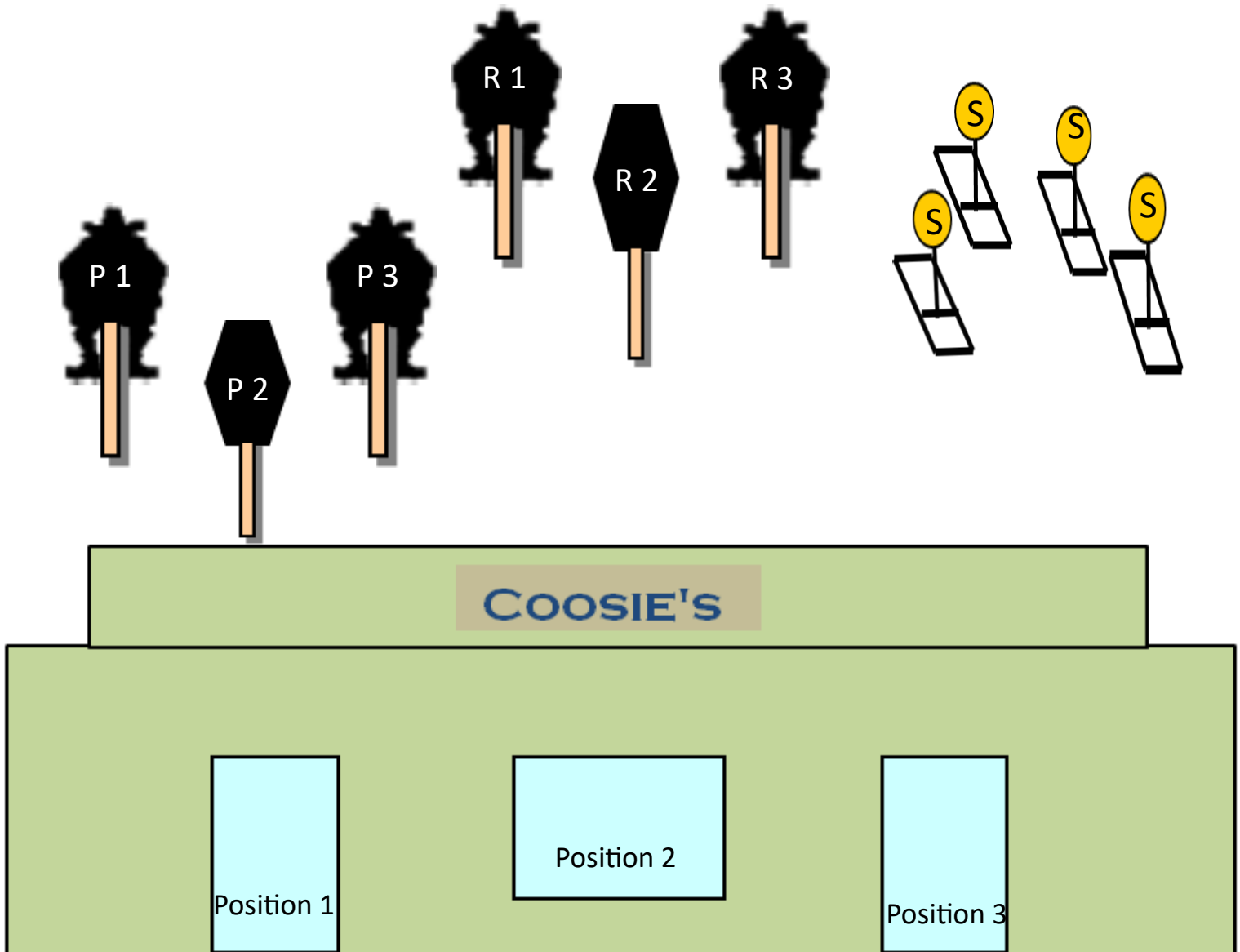

Shooter starts at the center of position 3, shotgun at port arms. Revolvers loaded with 5 rounds each and holstered. Rifle loaded with 10 rounds staged at position 2.

When ready, shooter says: JUST SHOOT THE DAMN THING ON THE COUNT OF 3.

ATB: With shotgun engage the shotgun targets any order.

Move to position 2 and with rifle, engage the rifle targets as follows: sweep R1,R2,R3,R2,R2 and Repeat for the next 5 rounds.

Move to position 1 and with revolvers engage P1 thru P3 with the same instructions as the rifle.

**WHAT THE 170 (SHOTGUN) 1,2,3,2,2 sweep twice**